



EN

Models
WT-1-EU-W
WT-1-EU-S



OPERATING INSTRUCTIONS INSTALLATION INSTRUCTIONS



**Please read these instructions carefully before installation and commissioning.
Failure to follow the safety instructions can lead to damage to the machine and vehicle!**

2.08 23.04.2024
Subject to change.



WEEE-Reg.-Nr. DE 89158996



Disposal

The packaging protects the device from transport damage and is recyclable. Returning the packaging to the material cycle saves raw materials and reduces waste. Your specialist dealer will take back the packaging.



Electrical and electronic equipment contains valuable, reusable materials. They also contain certain substances, mixtures and components that were necessary for their function and safety. In household waste, as well as if not handled properly, they can be harmful to health and the environment. If you do not dispose of your old appliance with household waste, please use the official collection and collection points to hand in and recycle the electrical and electronic equipment at your municipality or dealer.

tinyWASH products are registered with the EAR Foundation (Stiftung Elektro-Altgeräte Register) for electrical appliances sold in Germany. The registration number is DE 89158996.

Registering your device

Please register your device at <https://www.tinywash.de/registrierung>.
The data protection guidelines published under www.tinywash.de apply.



QR-Code Registrierung

Instruction manual changes and updates

These operating instructions will be revised and supplemented if necessary. The latest version of this manual as a PDF can always be found under <https://www.tinywash.de/anleitung>.

If you need your instruction manual and don't have it handy, you'll find a QR code on the machine, next to the detergent compartment. This code will take you directly to the download of the latest version of this manual.



QR-Code Anleitung



TABLE OF CONTENTS

Equipment	3
Safety	4
Overview / Scope of delivery	8
Installation / Assembly	9
Preparation	14
Control display overview	15
Detergent dosing unit	16
Start the washing process	17
Program selection	18
Program settings	19
Other functions	20
Start / end of washing program	21
Cleaning the machine	22
Emergency draining / Emergency unlocking	23
Frost protection / winter emptying	24
Operation, Faults & Causes	25
Service	27
EU Product Information Sheet / Product specification	28



DD direct drive motor, ultra-quiet

Thanks to the direct drive, the machine runs smoother and quieter.

Touch Control

Easily select all programs and settings via the touch control panel.

Automatic detergent dosing

Precise detergent dosing not only saves time, but also reduces the consumption of detergent.

Sensors

Sensor-based determination of the load and automatic adjustment of the running time and water quantity.

Hot wash

Wash at up to 90°C.

Built-in dryer

Dryer function with running times between 30 and 180 minutes.

Self cleaning function

Regular use increases the service life of the device and cleans both the washing drum and all internal sewer pipes.

Quick wash

Energy- and water-saving quick wash program with only 15 minutes running time.

Smart installation

Space-saving installation on the wall or with a mounting kit.

Emergency drain and emergency release

In an emergency, e.g. In the event of a power failure, the machine can be drained and opened via the emergency drain so that the laundry does not remain in the water for too long.



Do not operate the machine while driving.



In winter (temperatures in the vehicle below 4°C), completely empty the water supply and drain pipes. Risk of frost damage. Please also refer to the chapter on frost protection.



Please also note the other safety instructions in the chapter Installation.



Do not use the appliance if the power cord is damaged.



Please disconnect the power supply when the appliance is not in use, smoke or unusual odors develop.

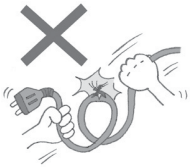

Please do not kink, twist or damage the power cable. Also, do not place heavy or sharp-edged objects on the cable.

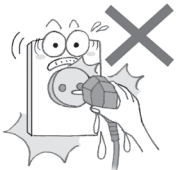

Do not plug in or out with wet hands.

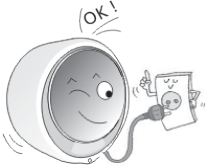

Make sure that the connected power supply is compatible with the device (220 – 240 volts / 50 – 60 Hz) and that the supply is designed for 10A.



The grounding of the device must be ensured for your safety.

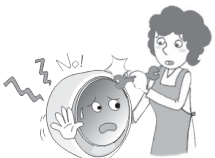

Do not make any changes to the device.

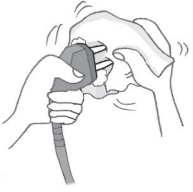

Please clean the pins of the plug if they are dirty.

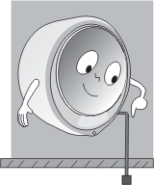

In the event of a gas leak (not emanating from the machine), do not operate the appliance and ventilate sufficiently.



Protect the machine from rain and wind.



Do not use aggressive substances or chemicals, except household detergents.



Unplug power before maintenance or cleaning.



During operation, do not reach under the lid of the washing machine or insert other objects.



Do not install near fire pits.

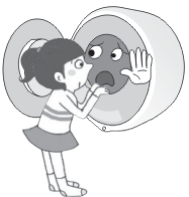

Pay attention to children, there is a risk of injury.





If the machine is not in use for a long time, pull out the power plug.



Do not place any objects on the appliance.



If the door is locked, do not force it open.



Do not put animals in the machine.



Check for water leakage before using.



Do not bring magnets near the device during operation.



Installation only on sufficiently stable wall elements or with the installation kit.



Do not use laundry bags.

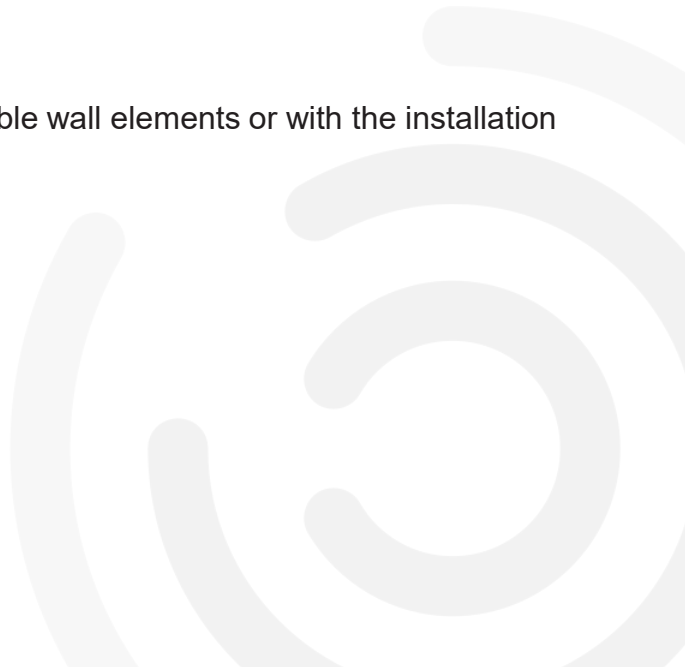



Do not operate the machine if it is tilted or tilted. Only in a vertical position.



Do not wash sleeping bags or waterproof dung such as rain jacket, leather, etc.



Clean the appliance only with soft cloths.



When closing the door, make sure that no clothes are pinched.



Turn off the water after use.



Make sure that the water is completely turned off.



Use the machine only for clothing – not for shoes, food, etc.



Before dismantling, remove water and detergent from the machine.

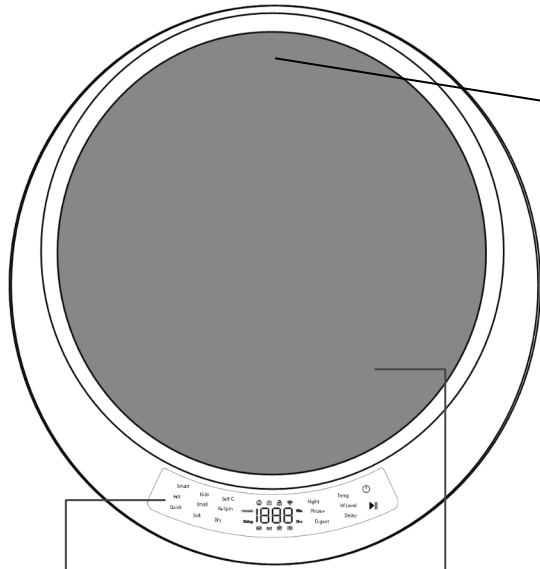

Display

Door

Do not open during the washing process

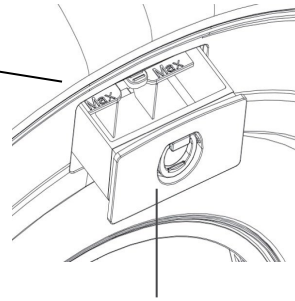

Detergent dosage (behind the door)



Power connection Schuko



Water connection with quick coupling

Scope of delivery: mounting material



Fresh water hose



Retaining ring for fresh water hose



Waste water hose with clamp



Water connection with quick coupling

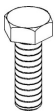

4x M10 screws with washers and nuts

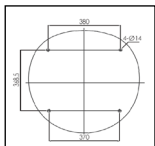

Drilling template scale 1:1



Initial preparation before commissioning

A slight leakage of water from the device may occur during the installation process. This is not caused by malfunctions or mechanical failure, but by water residues left in the device after the factory quality and functional check.

Connect the water inlet hose and turn on the tap.

Check if there is any water leakage around the hose and at the water connection.

The water inlet hose must be connected to the water inlet of the washing machine. It must be connected to the connection on the machine and locked with the retaining ring.

Plug in before the power plug

Check the grounding of the outlet to avoid electric shock.

Check that the outlet is designed for the maximum power load of the washing machine of 10A. Check whether the supply voltage of 220 – 240 volts is present.

Water and ambient temperature

This washing machine is designed for a maximum of 60°C tap water, please do not connect the water inlet hose to hotter water sources.

If you are using the machine for the first time, please install the sewer hose and the supply hose of the washing machine according to chapter "Installation / Assembly".

If the machine is used in an environment with a temperature of zero degrees or below, the water inlet valve and drainage system may be damaged. You must first raise the ambient temperature and bring the device to room temperature, which can take up to 24 hours. Only after that turn on the device.

Hot water supply

For the fixed connection to the motorhome / boat on-board water system, we recommend the connection to the cold water pipe of your vehicle / boat. If you also want to wash independently, we recommend that you add hot and cold water to tinyWSH and install a mixer. In this way, with self-sufficient operation and supply of warm fresh water, significant electrical energy can be saved when heating the water. Please note that you will need to switch the mixer back to cold water for drying operation, otherwise the dryer will not work and the laundry will remain wet.





Mounting location and fastening - centrifugal forces



During the spinning process, enormous centrifugal forces are generated, which must be dissipated via the fastening / supporting structure. We strongly recommend that the installation in the vehicle be carried out by a specialist workshop. It must be ensured that the load-bearing structure of the vehicle (wood panelling, etc.) to which the machine is attached is suitable for these loads. Talk to your vehicle dealer or vehicle manufacturer about this. Improper fastening or incorrect choice of installation location can result in damage to the machine and vehicle! Check regularly whether the fastening has loosened and adjust if necessary. The machine must not have any play on the fastening, otherwise it can swing up.

1. Installation location

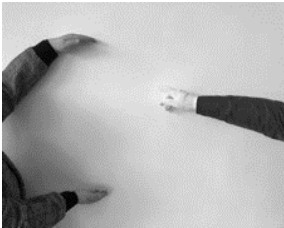

Choose the installation location. See also the security notice at the top of the page. The weight of the machine must be transferred to the floor of the vehicle in a constructive way. Don't just attach it to the wall!

2.a Reinforce wood cladding

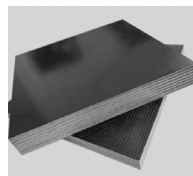

The fairing of your motorhome does not wear the machine permanently. Reinforce with an attached multiplex board, at least 15 mm thick, size min. 60 x 60 cm, screwed over a large area, glued if possible and standing up on the vehicle floor.

alternative

2.b Mounting with installation kit

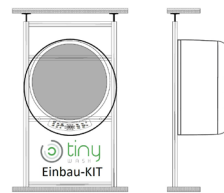

Mounting with tinyWASH installation kit.

3. Remove the housing cover

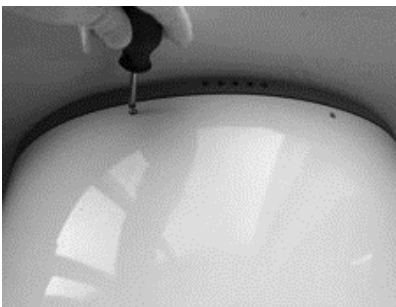

You have to remove the 2 screws from the top and bottom of the case to remove it.

4. Drilling

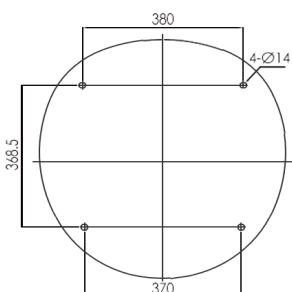

For the 4 suspensions of the machine for M10 or M12, drill screws in the attached mounting plate / support structure (drilling template enclosed). Alternatively, you can use the optional installation kit, in which the corresponding holes are already available.



Position suspension / holes

Stencil (M 1:1) is included in the delivery and is available for download in format DIN A1 at www.tinywash.de/anleitung .

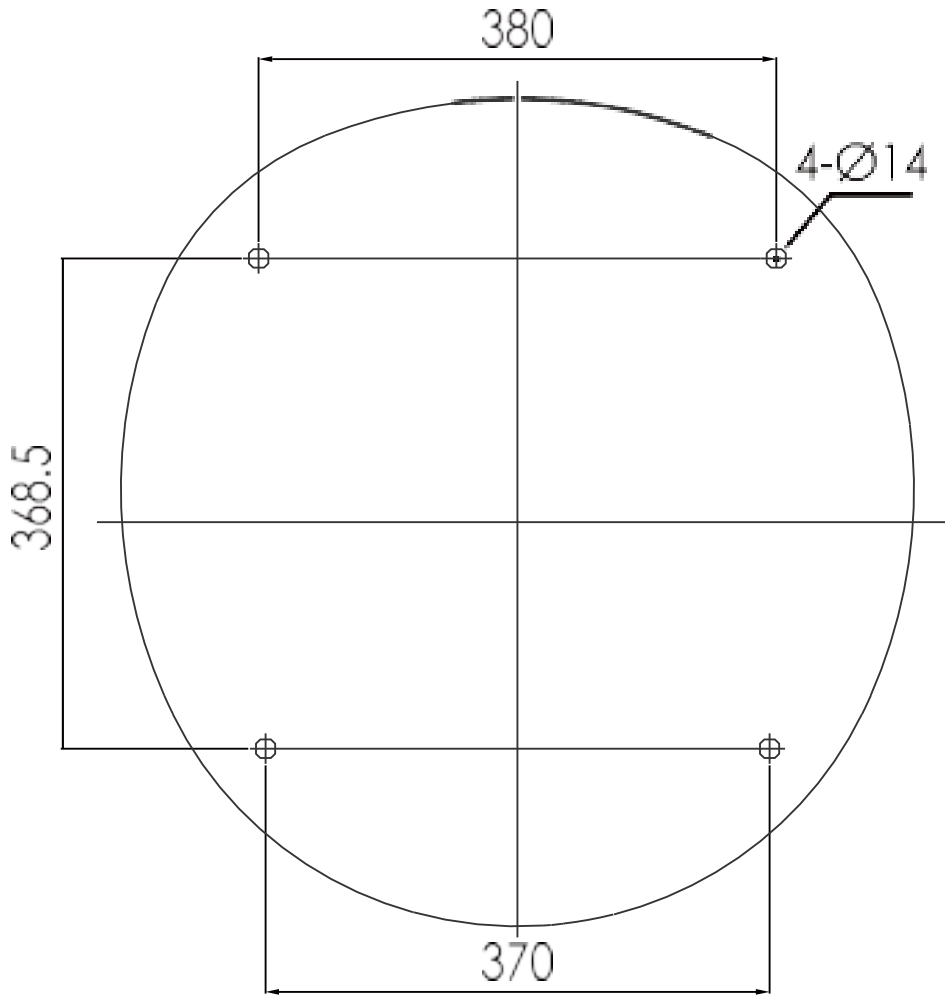



5. Connecting the water supply line

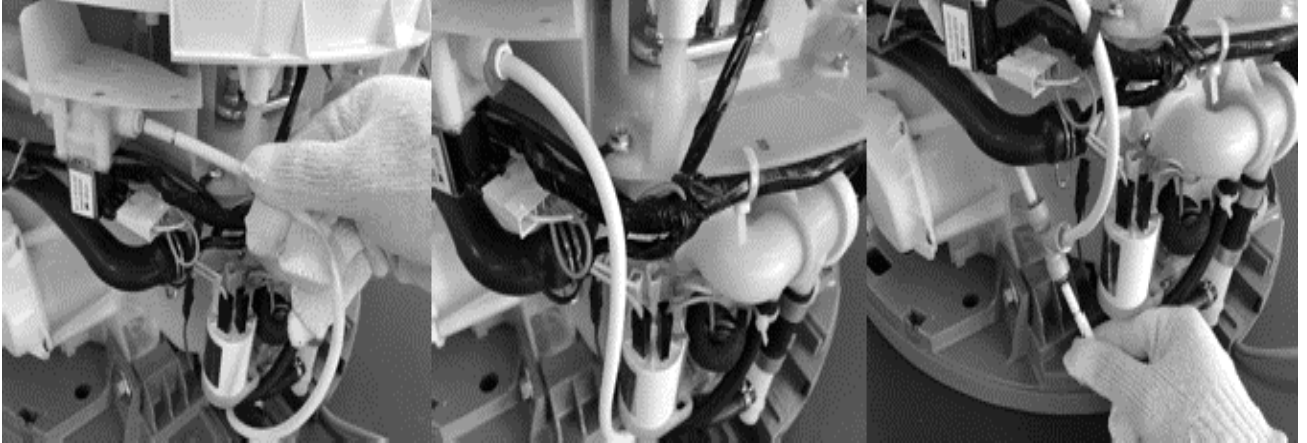

Insert the water inlet pipe into the water inlet valve coupling, minimum depth of 15 mm or more (black line on the hose) and install the retaining ring.

6. Connect the sewage pipe, insert the pipe into the housing

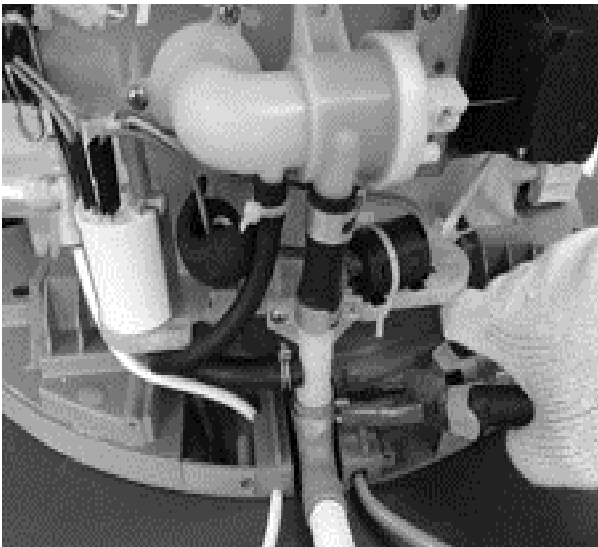

Attach the sewer hose to the drain connection and fix with the pipe clamp.

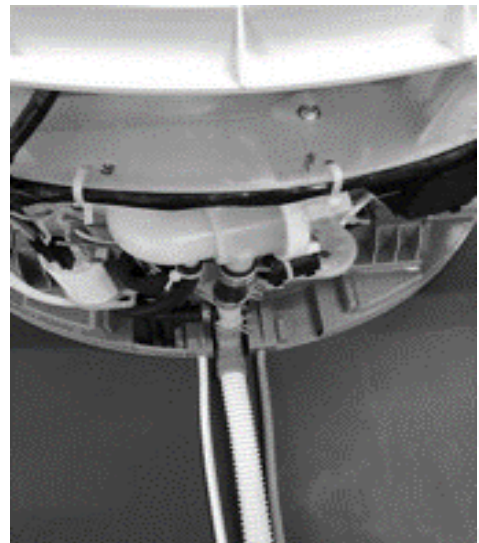

Place the water supply pipe and drain hose in the bushing of the housing. Make sure that none of the wires are kinked.



Due to its design, the machine does not have a sewage pump. Provide a sufficient slope of the sewer hose to the waste water tank or canister and to a free inlet to avoid the backflow of water. Optionally, an additional sewage lifting pump can be installed (available as an accessory).



7. Hanging and fastening the machine

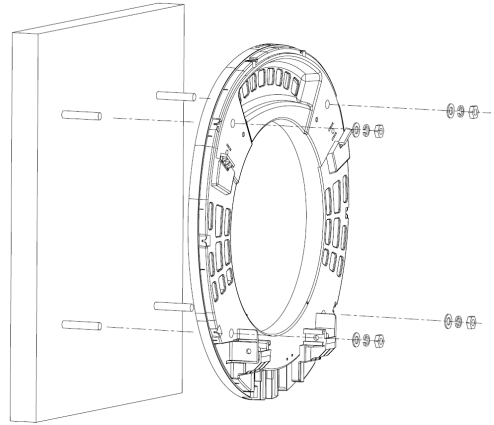
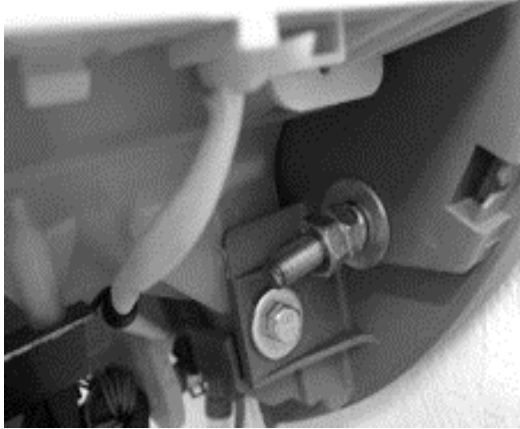

Fastening with 4x M10 screws and nuts, as well as washers and spring washers. Screws are guided through the wood reinforcement (see 2.a) and countered on the back with nut and washer. Alternatively, installation with original installation kit, available as an accessory, or by means of another supporting structure made of sturdy aluminium profiles (at least 40x40 mm) or comparable.



It is imperative to observe the safety instructions at the beginning of this chapter!

8. Connection of the water supply line to the vehicle's electrical system

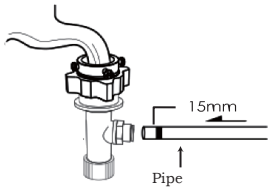

Connect the water inlet tee to the faucet or a "Gardena" quick coupling, insert the water inlet pipe into the water inlet tee, the insertion depth is 15 mm.

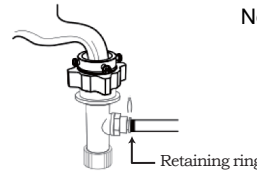

Next, install the retaining ring.



The washer-dryer requires a water pre-pressure from your vehicle's electrical system. Your vehicle must have an appropriate pressurized water system, alternatively you can install our optional pressurized water pump, available as an accessory.

9. Test run and reassembly of housing cover



Plug in the power plug and perform a test run to check for leaks before installing the lid.

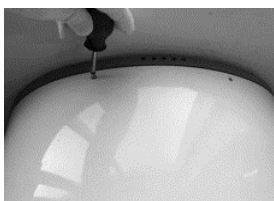

Put the housing cover back on the device and secure it with the 4 screws.



Risk of electric shock! This step must be carried out by a qualified electrician. Do not touch any cables and contacts inside the machine!



Check the washing label on the laundry to see if it is suitable for machine washing. Otherwise, if the wrong washing method is chosen, it may cause damage or deformation of clothes. Clothes with large lint or hair should only be washed after removing lint or hair to prevent the lint or hair from sticking to the clothes after washing. For clothes with a lot of mud and dust, please clean the mud or coarse dirt before washing. If it is a particularly dirty part, please apply the detergent to the garment in advance so that the dirt can be removed more easily.

To improve the washing effect, please wash dark and light clothes separately. When washing the clothes, please distribute them evenly in the washing drum.

Please wash clothes that are prone to pilling, or have larger buttons, inside out to avoid the buttons colliding with the inner wall of the drum and making noise during the washing process.

Please remove coins, hairpins and other debris in your laundry to avoid drainage pipe blockages and product failure. Please repair damaged clothes before washing. Do not put clothes contaminated by chemicals directly in the washing machine, but rinse them in advance.



Washable materials

- Underwear and socks
- Pants, skirts, sweaters, light jackets and T-shirts
- Towels, cloth handkerchiefs, pillowcases, tea towels and cleaning rags
- Baby clothes, diapers and underwear
- High-quality clothing, such as shirts, knitwear



NOT washable materials

- Products containing foamed polyurethane (sponge)
- Woolen blankets, electric blankets, blankets with a hair length of more than 10 mm, carpets
- Pet hair mats and floor mats
- Leather
- Down clothing
- Curtains
- Bathrobes, bathroom mats, thick sportswear, etc.
- Shoes





Display

1888 Remaining time.

Parental lock: Press the Temp button for 3 seconds, the icon will light up and the function will be active.

Detergent dosage: Tap D-gent, the icon will light up and the automatic dosage will be active.

Auxiliary functions

[Temp]
Select the desired water temperature by tapping on it.

[W-Level]
Set the desired amount of water by tapping.

[Delay]
Delay. Tap in standby to set the desired end time (between 1:00-24:00 hours).

Program

[Smart] [Hot] [Quick] [Kids]
[Smalls] [eco 40-60] [Self-C]
[R+Spin] [Dry]

Select the desired program by tapping on it, the correspondingly selected program will light up.

Power on/off

Tap to turn on the machine. To turn off manually, press and hold the button for 3 seconds.

The machine will automatically shut down 3 minutes after switching on if no program is started.

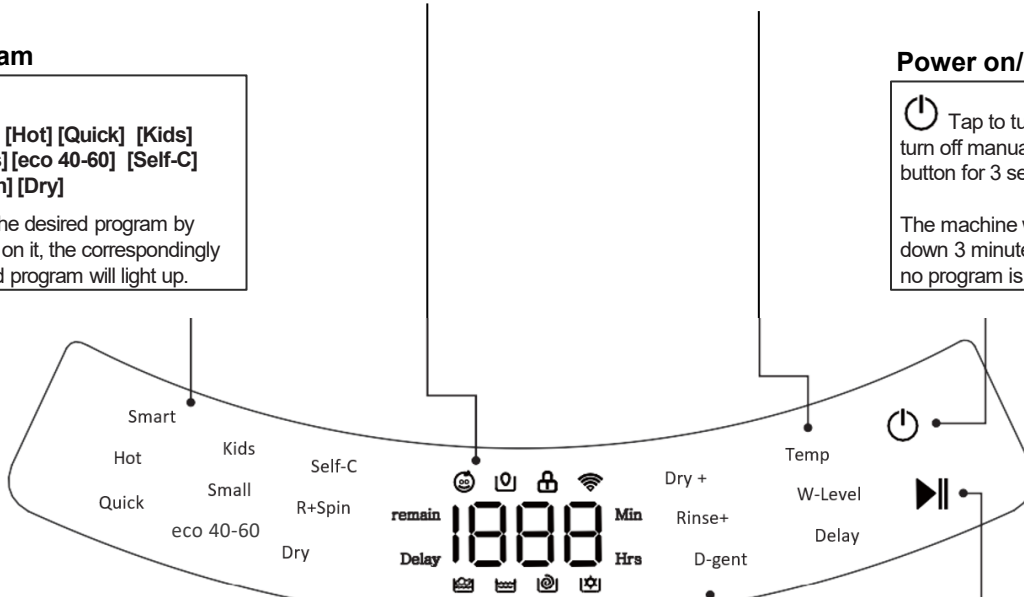

- [Wash]
- [Rinse]
- [Spin]
- [Drying]

The flashing symbol indicates the current operating mode.

Status

[Dry +]
Tap this test after selecting the washing program. Drying will be activated and will start automatically after the washing process. By tapping several times, you can set the running time of the drying process in minutes (30, 60, 90, 120, 180)

[Rinse+]
Tap to set the rinse time.

[D-gent]
Tap to activate the automatic dosage of the detergent, increase the amount or deactivate the automatic dosage (symbol off).
The icon flashes when detergent needs to be refilled.

Auxiliary functions

Tap to start/stop the chosen program.
If the parental control is activated, this first must be deactivated.

To add clothes while the program is running, tap the **Start/Pause** button.
The machine checks water level, engine, temperature. If it is possible to add it, the machine will automatically open the door. Add laundry, close the door and press **start/pause** again to continue.

Start / Pause



Automatic addition of detergent

This machine has the function of automatic detergent addition, which can store a large amount of liquid detergent at the same time for several washes. The washing machine can automatically adjust the dosage of the detergent according to the load. The user can also touch the "D-gent" function button to select the dosage, the larger the number, the higher the dosage. (We recommend that users use the default settings.)

(1) Open the door, pull the tab on the upper part of the front panel, and pull out the detergent drawer.

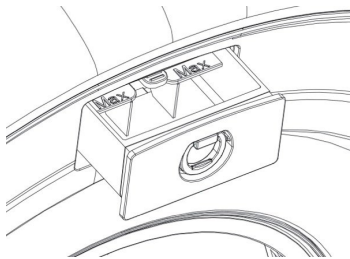

(2) Slowly pour in liquid detergent. Note that the MAX mark is not exceeded. (Note: max. 400 ml for the first filling). Then close the thrust again.

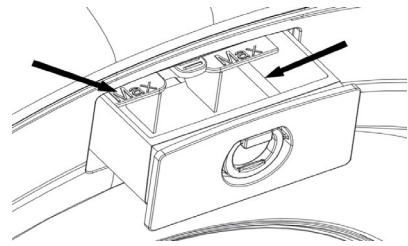

POUR ONLY LIQUID DETERGENT WITH LOW VISCOSITY, DILUTE WITH WATER.
MAX 400 ml

Add detergent manually

Before starting the washing program, press the "R-gent" function button until the value "0" is displayed. After the automatic dosing has been deactivated in this way, you can add the detergent directly to the washing drum as needed.

How to use automatic detergent dosing

All washing programs of this machine are set by default with the automatic dosing function. The washing machine automatically adjusts the dosage according to the clothes and load. You can also press the "D-gent" button to disable ("0") or change the automatic dosing. (The default setting of the washing machine is the recommended dosage).

In order to use the automatic dosing function for the first time, the detergent must fill the internal pipeline. You can choose "3" to increase the amount of detergent.

After changing the detergent amount you need to press the washing program button (e.g. SMART, QUICK, etc.) to save your settings.

When pouring liquid detergent into the drawer, do not exceed the maximum "MAX" mark. It is recommended to dilute an excessively viscous detergent with water before filling. Please use low-foaming liquid detergent suitable for drum washing machines

Reminder of insufficient detergent level: Before the washing machine is running, the "detergent" icon  on the display flashes quickly, indicating that the detergent level is insufficient and needs to be replenished.



Open the door and insert the clothes

To ensure the best washing balance and prevent wear and tear of clothes, please distribute the clothes evenly in the drum.

Close the door

When closing the door, be sure to insert the clothes completely into the washing drum to avoid water leakage, blockage of the electronic door lock, or damage to the clothes caused by the clothes being jammed by the door.

Switching on and starting

Touch the [Power]  button to turn on the device.

After the device has been switched on, the buttons on the touch control display are all switched on. After 3 seconds, the washing machine will go into standby mode. From this point on, you can touch the buttons to make your settings. If there is no operation within about 3 minutes or the washing machine is not started within about 3 minutes after selecting the program, the washing machine will automatically switch to standby.

Select a washing or drying program, change the settings for temperature, amount of water, amount of detergent, rinsing and drying time if necessary, and then tap the Start  button.

If the washing machine is running and an error message is displayed or needs to be turned off, touch the Power button  for about 3 seconds to turn off the washing machine.



Touch a button to select the desired program.



Smart

Suitable for cotton, linen, synthetic fiber, etc.

Hot

Intensive care up to 90°C.

Quick

Quick cleaning for lightly soiled laundry, 15 min running time.

Kids

Intensive cleaning up to 60°C.

Small

For small items of laundry such as socks, underwear, etc.

eco 40-60

Energy saving program for clothes 40 – 60 °C.

Self-C

Drum self-cleaning with hot water. Do not include clothes or detergents.

R+Spin

Rinsing and spinning clothes after manual hand washing.

Dry (Dryer only)

For drying daily laundry (towels, socks, T-shirts, etc.) and other tumble dry laundry. After tapping the **Dry** function, select the appropriate drying time according to the texture and amount of clothing. The default time is 120 min, tap **Dry+** to select the drying time (30 min, 60 min, 90 min, 120 min and 180 min). The longer the drying time, the better the drying effect.

Maximum drying load 1.50 kg.

Leave the water inlet turned on during the drying process (Improves dryer performance)

After drying, the temperature of the drum cools down to a lower level before the door can be unlocked and opened after about 5 to 10 minutes. The remaining time to cool down is shown on the display.

Please note that the clothing may still be at a high temperature when removed.

Clothes can shrink and deform easily due to drying, check the clothes for dryer suitability.

To avoid damage to clothing and deformation, the degree of drying is set low. If the degree of drying is not sufficient, press the drying program again.

To cancel, press **POWER** for 3 seconds in the drying process, the clothes are cooled, and the door can be opened after the cooling is complete.

HINT The SMART program intelligently adjusts based on information such as the material and weight of the laundry, and the program time is subject to change.
If the water pressure is too low, etc., the program time may change.
It is recommended that users run the drum cleaning program at least once every 3 months to clean the washing machine.



Touch a button to select the desired setting.

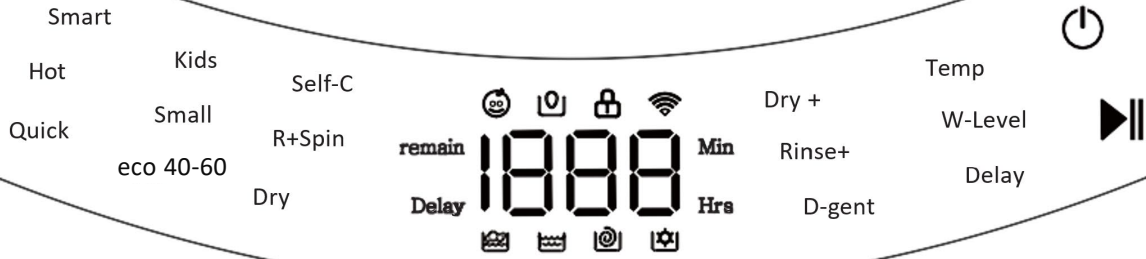

Dry +

With this function, you can set the duration of the drying program in 30-minute increments. The standard is 120 minutes. In addition, you can activate the drying of the laundry after the end of the previous washing program. (Washing + drying in one drain)

Rinse +

Different rinsing times can be set in the Smart, Quick, Kids, Small, Soft, R+Spin programs. When choosing different rinsing times, the corresponding washing time changes.

D-gent

By default, the detergent dosage of this appliance is activated, you can adjust the amount of detergent of the dosage by tapping this button or disable this function (0 and symbol goes out) and manually add the detergent to the drum instead.

Temp

By tapping this button, different temperatures can be set in the Smart, Quick, Kids, Small, Soft, Rinse + Spin programs. The selected temperature is briefly displayed by tapping on the main display (1888).

W-Level

Different amounts of water can be set in the Smart, Hot, Quick, Kids, Small, Soft, Rinse + Spin programs. The higher the number on the display when tapping the button, the more water is used for the washing process.

Delay

This function is only available in standby mode, do not unplug it. To select the delay time, first select the washing program and the various functional parameters, then select Delay. (E.g. 2 hours (hrs), the washing process then starts in 2 hours).



Touch a button to select the desired function.

Parental Control

In order to protect the safety of children and prevent children from altering the washing process, this function is provided.

Activation

Before starting the washing program, touch the **Temp** button for 3 seconds, the icon lights up, the child lock function is turned on, and the buttons are still selectable; After the program has been started, the buttons (with the exception of the Power button) are not selectable.

Disable

Before starting the washing program or during the washing process, when the child lock function is turned on, touch the **Temp** button for 3 seconds, the buzzer will beep once, the icon will turn off, and the child lock function will be released. After the washing program is finished, the parental control function is always automatically terminated.

Add laundry during the program run

Press the Start/ Pause button, the machine will check the water level, temperature and motor, and open the door automatically if clothes can be added. Put the extra clothes in the washing drum. Press the Start/Pause button again to continue washing/drying.

Turn on the lighting of the washing drum

In standby, the drum light is on when the door is unlocked. When the door is locked, the light will turn off after a delay of 30 seconds. During the washing process, touch any function button, the drum light will light up and turn off again after a delay of 30 seconds. At the end of the program, the door lock is unlocked, the drum light turns on automatically for about 5 minutes, and then automatically turns off.



Start

Touch the [Start/Pause] ►|| button. You will hear a "click" when the door lock locks the door and the washing machine starts running. Please do not pull or pry the door during operation to avoid damage.

Door lock unlocking:

To ensure safety, the door is locked while the washing machine is running and the door lock symbol appears on the display.

If you need to unlock during the washing process, please touch the **start/pause** button on the control display first, and the door can be opened after the door lock icon goes out. In some cases, such as when the water level in the drum is too high, the temperature is too high, the drum rotates, etc., the door lock will not be opened immediately for safety. This is normal - wait for the water level and temperature to drop. The door can be opened only after the drum has completely stopped spinning. If you need to open the door lock in child safety mode, please disable the child lock first, and then touch the start/pause button to stop the operation of the washing machine to unlock the door.

Hint

With different water pressures, different fabrics and different amounts of laundry, the display time and the actual running time of the washing machine may be different.



End

Switch off

Take out the clothes

After washing, please take out the laundry in time. If left in the machine for a long time, the clothes are susceptible to wrinkles, bacteria and odors.

Open the machine door

To keep the drum of the washing machine clean, please open the door for a period of time and close the door only after it has dried.

Turn off the faucet

To avoid water leakage, please turn off the tap after washing. Unplug the power cord to avoid electric shock. Do not plug or unplug the power cord with wet hands.



Clean the machine regularly so that you can enjoy your device in the long term.

Before cleaning, please unplug the power cord. For cleaning, please do not pour water over the housing of the machine, this can lead to a defect.



Cleaning the washing machine

Use a clean, damp cloth to clean the washing machine. Do not rinse the case directly with water. Do not use synthetic detergents or detergents containing benzene, otherwise the plastic parts of the washing machine may be damaged.

Do not use thinner, gasoline, alcohol and other volatile materials for wiping.



Cleaning the washing drum

Rust

If you put contaminated water or rusty objects such as hairpins in the drum, or if water stays in the drum for too long, it can cause rust.

Remove rust

Press a rust removal paste onto a soft cloth or sponge, then wipe off the rusty part. Do not use wire brushes, otherwise the drum will be damaged.

Detergent residues

(Dark streaks and spots) If you use the washing machine for a long time, add too much detergent or repeat the washing process with detergent that is not completely dissolved, it can cause detergent residue to contaminate clothes.

Washing drum self-cleaning

Run the Self-C program at regular intervals.

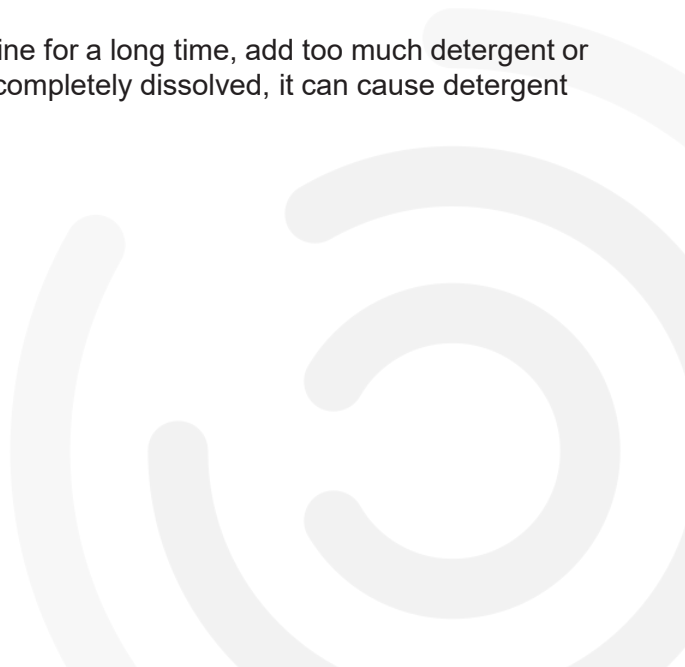



Emergency drain hole
Cap



Door unlock

Draining

Use a screwdriver to unscrew the emergency drain cap mounting screw.

Disconnect the emergency drain pipe from the emergency drain plug, align the nozzle of the pipe with the container prepared in advance and allow the water to drain into the container.

After the water is drained, put the emergency drain plug back into the emergency drain pipe, paying attention to the end of the pipe. Use a Phillips screwdriver to retighten the emergency drain plug.

Note: Please use this function only in case of emergency!

Emergency release (not all models)

If the door does not open electronically (most often if laundry has jammed when the door is closed, or if there is error code E06), you can unlock the machine in an emergency.

Use a screwdriver to unscrew the emergency door opening cover mounting screws.

Hold the emergency door opener and pull the wire rope down slightly. After hearing a slight clicking sound, you can open the door and take out the clothes. The wire rope retracts after release.

Use a Phillips screwdriver to reattach the emergency flap to open the door.

Note: Please use this function only in case of emergency.



If you park your vehicle outdoors during the cold season or in an environment that is not protected against frost, you must remove the residual water from the water supply line and the device in order to avoid frost damage to the supply line and the machine.



Start

1. Draining the supply water pipe

Disconnect the fresh water supply line from the tap or water connection of your vehicle and ensure that residual water can drain out of the hose by means of appropriate storage (slope) of the water hose. After that, do not reconnect the hose to the tap, but place the open end over a small collection vessel.

2. Emptying the machine

Turn on the appliance and add two dry towels to the drum. Then start the drying program (Dry) for 30 minutes. At the beginning of this washing program, the tinyWASH opens the waste water valve and later (approx. 10 minutes after the start of the drying process) the internal water inlet valve, which allows any residual water from the machine's pipes to drain into the previously emptied supply water hose (1.).

Let the program run for the full 30 minutes until the end. Then please remove the towels, disconnect the appliance from the mains and leave the flap of the washing drum open to prevent mould growth.

3. Drain the supply water pipe again

Empty the supply and waste water hose again to remove any water that may have run back from the hose.



End



Some problems are mistakenly considered to be glitches when they are not. If an error is suspected, first check the solution to the corresponding problem in the following table. If it still cannot be solved, please contact the seller or service center for advice.

Problem	Testing and solution
Machine interrupts washing process	Unplug it, wait 15 seconds, and plug it back in. After that, start the washing process again. If the error occurs again, contact the service.
Machine does not draw water	Check that the water supply valve is open.
Machine drains water during washing	Are you using too much detergent? If there is too much foam on the clothes, water is drained during the washing process.
Water absorption during spinning	During the spinning process, the washing machine restores the water supply to remove detergent residues.
Washing program runs too long	Low water pressure prolongs the water supply and the entire washing cycle.
Noises during spinning	Check the load and whether there are any items in the drum.
Fluctuations in the remaining time	If the clothes are unevenly distributed in the drum, the remaining time will be extended.
Remaining time remains unchanged	The temperature inside the drum is too high, wait for it to cool down to avoid burns.
The laundry is still very wet after spinning	In the Quick program, the laundry is only spun on briefly, which is why more water remains in the laundry. If the spin power is not sufficient in a regular program, you can also start the DRY program briefly. Here, the laundry is spun again intensively. After spinning, simply cancel the DRY process manually.
After the start of spinning, the drum rotates very slowly	If too much detergent is added or the middle part of the drain pipe is bent upwards, resulting in poor drainage, the spin speed will decrease. Start the rinsing process again.
Control display does not respond	Check if the parental control feature is enabled.
There are small water residues in the machine during commissioning	Normal. A small amount of water remains in the machine after the factory inspection.
Machine interrupts washing process	Check if the power has suddenly been cut off or the water has been turned off; whether the start/pause button has been pressed
Strong fluctuations in the remaining time	If the remaining running time fluctuates very strongly (up to 500 minutes), there is a sensor error, which leads to an incorrect time, but not to an actual extension of the washing time. You can run the washing program to the end. Then disconnect the machine from the power supply for a short time – this resets the error.
Machine draws water when drying	The machine needs fresh water to cool the condenser during drying, this is completely normal. Depending on the load of the machine, it requires up to 30 litres of water per hour of drying process.



Error Codes

The machine interrupts the program and reports the following error codes in the main display (remaining time)

Error code	Testing and solution
E01	The machine does not receive fresh water. Check the faucet and supply pipe.
E02	When drying: Waste water does not drain or does not drain quickly enough. Check the sewer line for slopes, kinks and blockages.
E04	When washing, rinsing or spinning: Waste water does not drain or does not drain quickly enough. Check the sewer line for slopes, kinks and blockages.
E06	Door lock blocked. Disconnect the machine from the power supply and wait 15 seconds. Plug it back in and try again. If the door still cannot be opened, use the emergency release. This error most often occurs when laundry items are trapped in the door or lock. Caution: this may cause damage to the electronic lock.

Additional faults can be found online: www.tinywash.de/FAQ.



Within the framework of the conditions published on the website, under tinywash.de, tinyWASH offers a comprehensive service and a Europe-wide mobility guarantee.

In the event of a malfunction of your device, please contact us during business hours by phone at +49 911 99 08 74 33.

Alternatively, you can reach us around the clock by e-mail at service@tinywash.de.

E-mails to this address will also be processed promptly outside business hours.





Product Information Sheet

COMMISSION DELEGATED REGULATION (EU) 2019/2014 with regard to energy labelling of household washing machines and household washer-dryers

Supplier's name or trade mark: tinyWASH

Supplier's address: Campinvent UG haftungsbeschränkt, Merkurstr. 21, 90763 Fürth, DE

Model identifier: WT-1-EU-W / WT-1-EU-S

General product parameters:

Parameter	Value		Parameter	Value	
Rated capacity (kg)	Rated capacity ^(b)	1,5	Dimensions in cm	Height	62
	Rated washing capacity ^(a)	2,5		Width	58
				Depth	35
Energy Efficiency Index	EEl _W ^(a)	51,9	Energy efficiency class	EEl _W ^(a)	A
	EEl _{WD} ^(b)	173,9		EEl _{WD} ^(b)	G
Washing efficiency index	I _W ^(a)	1,040	Rinsing effectiveness (g/ kg dry textile)	I _R ^(a)	4,9
	J _W ^(b)	1,040		J _R ^(b)	4,9
Energy consumption in kWh per cycle, for the washing cycle of the household washer-dryer, using the eco 40-60 programme at a combination of full and partial loads. Actual energy consumption will depend on how the appliance is used		0,327	Energy consumption in kWh per cycle, for the wash and dry cycle of the household washer-dryer at a combination of full and half loads. Actual energy consumption will depend on how the appliance is used		1,746
Water consumption in litre per cycle, for the eco 40-60 programme at a combination of full and partial loads. Actual water consumption will depend on how the appliance is used and on the hardness of the water		32	Water consumption in litre per cycle, for the wash and dry cycle of the household washer-dryer at a combination of full and half loads. Actual water consumption will depend on how the appliance is used and on the hardness of the water		96



Maximum temperature inside the treated textile (°C) for the washing cycle of the household washer-dryer, using the eco 40-60 programme	Rated washing capacity	35	Maximum temperature inside the treated textile (°C) for the washing cycle of the household washer-dryer, using the wash and dry cycle.	Rated capacity	35
	Half	34		Half	34
	Quarter	34			
Spin speed (rpm) ^(a)	Rated washing capacity	760	Weighted remaining moisture content (%) ^(a)	84,0	
	Half	760			
	Quarter	760			
Eco 40-60 programme duration (h:min)	Rated washing capacity	2:42	Spin-drying efficiency class ^(a)	F	
	Half	2:06			
	Quarter	2:05			
Airborne acoustical noise emissions during the spinning phase for the eco 40-60 washing cycle at rated washing capacity (dB(A) re 1 pW)	71	wash and dry cycle duration (h:min)	Rated capacity	5:10	
			Half	5:07	
Type	Free-standing	Airborne acoustical noise emission class for the spinning phase for the eco 40-60 programme at rated washing capacity	A		
Off-mode (W) (if applicable)	0,44	Standby mode (W) (if applicable)	0,00		
Delay start (W) (if applicable)	2,73	Networked standby (W) (if applicable)	0,00		
Minimum duration of the guarantee offered by the supplier: 24 months					
This product has been designed to release silver ions during the washing cycle		NO			
Additional information: Color: Silvergrey					
Weblink to the supplier's website, where the information in point 9 of Annex II to Regulation (EU) 2019/2023 is found: http://www.tinywash.de					

^(a) for the eco 40-60 programme.

^(b) for the wash and dry cycle.



tinyWASH

WT-1-EU-W

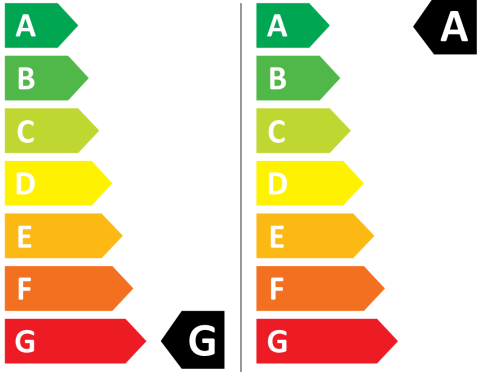

174 kWh / 100
52 kWh / 100

1,5 kg **2,5 kg**

96 L **32 L**

5:10 **2:42**

ABCDE**F**G

71 dB

ABCD

2019/2014



tinyWASH

WT-1-EU-S



174 kWh / 100
52 kWh / 100

1,5 kg **2,5 kg**

96 L **32 L**

5:10 **2:42**

ABCDE**F**G

71 dB

ABCD

2019/2014





Technical data

Weight	17kg
Width	58.2cm
Height	62.1cm
depth	14"
Power connection	220 - 240V 50/60Hz
Maximum power consumption	1500W
Sound dB(A)	Washing < 45 dB Spin < 71 dB
Water pressure	0.3 to 4 bar
Water temperature inlet	10°C to 60°C (supply water temperatures above 30°C significantly reduce the electrical energy requirement per wash cycle)

Washing performance

Nominal washing capacity	2.50kg * *Nominal capacity 2.50 kg, maximum capacity up to 3.3 kg
Nominal drying capacity	1.5kg
Sling	max. 850 rpm
Washing programs	Smart (automatic), Hot (hot laundry), Quick (quick washing program), Kids (intensive laundry), Small (for small laundry items), eco 40-60 (energy saving), R+Spin (rinse and spin), Drum Clean (self-cleaning of the laundry drum)
Washing program running times	Smart 49 minutes (running time changes automatically depending on load and temperature), Hot 95 minutes, Quick 15 minutes, Kids 70 minutes, Small 70 minutes, R+Spin 27 minutes, Drum Clean 66 minutes, Dry 30 - 180 minutes, eco 40-60 2:42 hr
Additional program option	W-Level (set water quantity), Temp (set temperature), Rinse + (set spin time), Dry + (set drying time), D-Gent (set detergent dosage), Delay (delayed program start)
Detergent dosage	Detergent storage container with automatic dosing. If automatic dosing is not desired, the function can be deactivated and the detergent (liquid, powder, tab) can be added directly to the washing drum.
Water consumption	12 liters per quick wash cycle, drying process approx. 10 to 15 liters per 30 minutes depending on the load
Power consumption	0,33 kWh in wash cycle eco 40-60, 0.37 kWh in the Quickwash washing cycle

Other features

drive	Speed-controlled motor direct drive
washing drum	stainless steel
service	Touch display
lighting	Illuminated washing drum
door	Emergency release mechanism
Water	Emergency drain mechanism





The tinyWASH brand, the tinyWASH logo and the tinyWASH design are protected throughout Europe. Use by third parties only with prior written permission.
tinyWASH is a product of Camplnvent GmbH – Merkurstr. 21 – 90763 Fürth
<http://www.tinywash.de> info@tinywash.de